



Sterling Couch Range



Therapy Couch Range



Clinical Couch Range



Patient Trolley Range



Home Care Bed Range

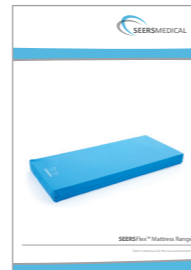

Replacement Mattress Range



**SEERS MEDICAL Ltd**  
Kenton Road,  
Debenham, Suffolk  
IP14 6LA, United Kingdom  
© Copyright SEERS Medical Ltd 2018

Company Reg. N° 6572698  
VAT N° 931596702  
Printed in the United Kingdom

Note<sup>1</sup>: The illustrated fabric colours may vary slightly from actual fabric supplied. This occurs due to the four colour printing process. However every attempt has been made to make them as accurate as possible. Our Policy of continuous improvement means that we reserve the right to change and modify designs without prior notice. Note<sup>2</sup>: Measurements may vary +/- 2° or +/- 5mm due to manufacturing tolerances



**Tel** +44 (0)1728 861 590  
**Fax** +44 (0)1728 861 868  
  
info@seersmedical.com  
www.seersmedical.com

Issue N° 018 v2  
Part N° 06Z-8008-SF



## Seating Range

Clinical & Rehabilitation Seating Products

## Introduction

Since **SEERS** Medical was founded in 2008, the company has always offered some basic chairs and stools to complement its range of medical furniture. Due to the increasing demand from customers to provide a complete range of clinical and patient seating, **SEERS** has developed a dedicated medical seating range to meet these growing requirements. In this brochure **SEERS** presents many new designs as well as a number of other complementary medical seating products that we distribute, providing a varied choice of models and options for various medical procedures and examinations.

The development of these products has been achieved by applying our many years of experience and knowledge in this market. Much thought has been given to the design, to benefit both the comfort and security of the patients as well as providing manual handling solutions which promote good posture and ergonomics to all clinical staff when they are using this equipment. With the management and control of our own assembly line at our premises in Debenham, Suffolk in the UK, our couches comply to the CE medical devices directive 93/42/EEC, ensuring we supply high quality products every time, with short lead times to meet the tightest of deadlines. We trust you will experience this yourself when you purchase a **SEERS** Medical product.

**SEERS Medical are ISO 9001:2008, ISO 14001 and ISO 13485:2016 accredited.**

## Contents

2-3	Introduction & Technical Information
4-5	Proximity & Dual Curve Medical Stools
6-7	Round & Square Medical Stools
8-9	Deluxe Saddle Chairs & Saddle Stools
10-11	Contoured Medical & Operator Chairs
12-13	General Medical Chairs
14-15	Surgeons & Sonographer Chairs
16-17	Laboratory Chairs & Stools
18-19	Multi Procedures Chair
20-21	Ophthalmology & Phlebotomy Chair
22-23	Orwell & Havering
24-25	Ixworth & Sorrell
26-27	Optional Accessories & Vinyl Colour Options



Anti-microbial vinyl upholstery



Crib 5 Fire retardant upholstery



Complies with EC Directive 93/42/EEC



Intelligent Ergonomic Designs

## Technical Information

The **SEERS** Medical Seating range includes a wide variety of ergonomically designed chairs and stools designed for clinicians, surgeons, therapists and more. All **SEERS** Seats are manufactured in Debenham, Suffolk and are individually inspected before being packed. This range complements the existing **SEERS** Clinical & Therapy Ranges, providing comfort and support to the person performing procedures. The collection of seats caters for a large variety of healthcare environments, including hospitals, general practices and therapy clinics.



## Here's what some of our customers think...



"Excellent service & great products"  
- Sandra



"No backache since purchasing one of your chairs"  
- Michael



"High quality & durable equipment"  
- Cynthia



"Great products with a reliable and friendly service"  
- Martina

**MC6105**  
55cm to 81cm

**MC6106**  
55cm to 81cm

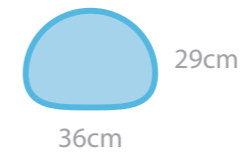

**MC6168**  
45cm to 59cm

**MC6169**  
54cm to 74cm

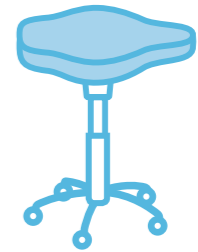

## Proximity Stools



This stool is intelligently designed to have one flat side, allowing the clinician to get in close proximity to the patient during a procedure. The stool is available in both standard and chrome bases, both with an excellent height range of 55-81cm. Included as standard with **SEERS** Echocardiography Couches.

### Models

- MC6105** Proximity Stool with black standard base and glides
- MC6106** Proximity Stool with chrome base, strut and glides



Model MC6105 Proximity Stool  
in Sky Blue

## Dual Curve Medical Stools



The dual curve medical stools feature an ergonomically designed seat pad, the curvature and static tilt of the seat encourages pelvic tilt, prevents slouching and promotes positive posture. An ideal suturing stool for clinical environments such as Delivery Suites, Theatres and A&E Departments, where the clinician is required to work in close proximity to the patient during these procedures. The foot height control option provides hands free height adjustment during these procedures.

### Models

- MC6168** Dual curve medical stool - standard model
- MC6169** Dual curve medical stool - high model  
Foot support ring fitted as standard.



All round height adjustment ring



Model MC6168  
Standard height model.  
Colour Tilleul



Model MC6169 Dual curve medical stool  
with foot height control option. Colour Tilleul



**MC6164**  
45cm to 59cm

**MC6165**  
54cm to 74cm

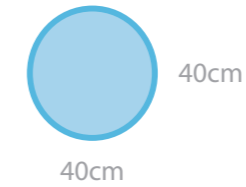

**MC6166**  
45cm to 59cm

**MC6167**  
54cm to 74cm



## Round Medical Stools



The clinical stool range has been designed to offer the clinician a variety of seat options, promoting optimum posture during various procedures. The stools are suitable for use in a wide range of clinical environments. The standard model provides a height range of 45cm to 59cm and the high model provides a height range of 54cm to 74cm. High models are supplied with an adjustable foot support ring as standard. The foot height control options provides hands free height adjustment.

### Models

**MC6164** Round medical stool - standard model  
**MC6165** Round medical stool - high model  
Foot support ring fitted as standard.

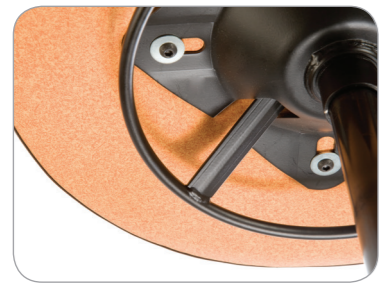

All round height adjustment ring, fully upholstered under side for ease of cleaning



Model MC6165 Round medical stool with optional foot height control. Colour Mandarin

## Square Medical Stools



These models provide the clinician with the option of a square seat pad promoting positive posture by allowing the legs to fall on either side of the seat corners, thus enabling the clinician to work in close proximity to the patient during an examination or procedure.

### Models

**MC6166** Square medical stool - standard model  
**MC6167** Square medical stool - high model  
Foot support ring fitted as standard.



Model MC6166 Square medical stool standard model. Colour oriflamme



Model MC6167 Square medical stool with foot support ring. Colour Oriflamme



Foot height control option available



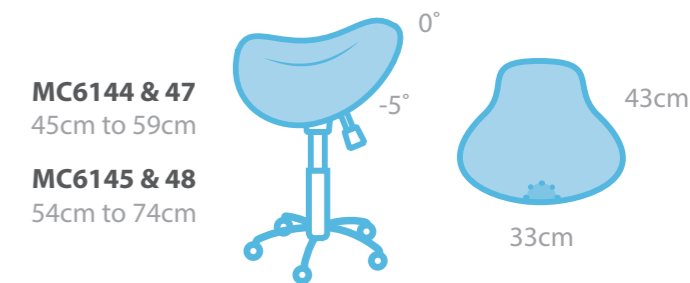
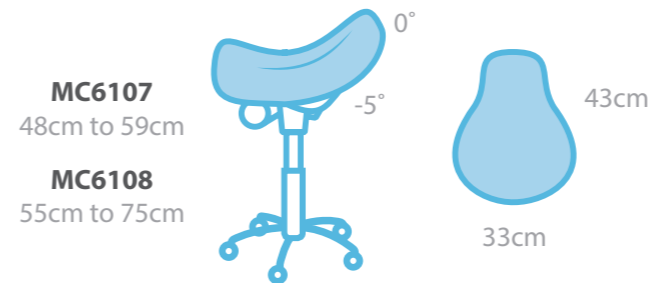

## Deluxe Saddle Chairs



The Deluxe Saddle Chairs are commonly used in Sonography, Dentistry and Surgical environments. The ergonomic design promotes positive posture by encouraging pelvic tilt whilst the user straddles the stool with both feet firmly on the floor and body weight is distributed through the thighs. The 2 lever mechanism operates and adjusts the seat height and tilt. All models feature a polished aluminium five star base and castors, with option of foot height control. An optional matching back support is also available if required.

### Models

- MC6107** Deluxe saddle chair - standard model
- MC6108** Deluxe saddle chair - high model
- Foot support ring fitted as standard.
- MC9123** Matching back support



High quality upholstery finish



Model MC6107 Deluxe Saddle Chair.  
Colour Dark Blue

## Saddle Stools



The new Coccyx Saddle Stool has a cut-out at the rear of the stool to reduce tail-bone pressure and pain during long seated procedures. The curved seat pad design provides a similar ergonomic seated position to the general saddle stool. Both the standard and the coccyx stools have a similar design to the deluxe saddle chairs, designed to encourage positive posture throughout seated procedures. The 2 lever mechanism operation provides independent adjustment for the seat height and tilt. All models feature a polished aluminium five star base and castors.

### Models

- MC6144** Saddle stool - standard model
- MC6145** Saddle stool - high model
- Foot support ring fitted as standard.
- MC6147** Coccyx cut-out saddle stool - standard model
- MC6148** Coccyx cut-out saddle stool - high model



Model MC6147 Coccyx cut-out  
saddle stool. Colour Dark Blue



Model MC6144 Standard saddle stool.  
Colour Lotus Green

**MC7212**  
45cm to 59cm

**MC7213**  
54cm to 74cm

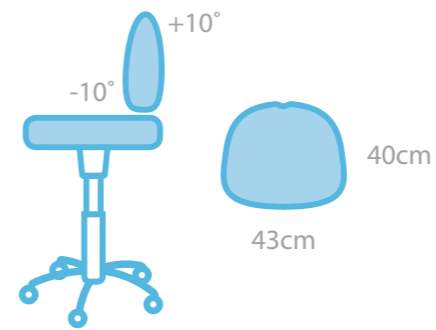

**ST6100**  
45cm to 59cm

**ST6101**  
54cm to 74cm

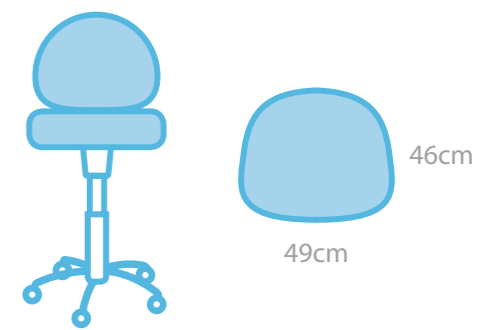

## Contoured Medical Chair



A versatile chair with a contoured seat pad and raised front to promote positive posture whilst seated. The 3 lever mechanism provides independent positioning of the backrest angle, seat pad tilt and chair height. The contoured backrest is ergonomically designed to provide lumbar support for the operator and has the option of foot height control.

### Models

- MC7212** Contoured medical chair - standard model
- MC7213** Contoured medical chair - high model  
Foot support ring fitted as standard

## Operators Chairs



A general operators chair with anti-microbial vinyl, ideal for a multitude of medical and clinical environments. Included with Medicare Deluxe Gynaecology Couch & various Clinical Packages.

### Models

- ST6100** Standard Operators Chair
- ST6101** High Operators Chair with Foot Support Ring & Glides





**MC6178**  
45cm to 59cm

**MC6179**  
54cm to 74cm

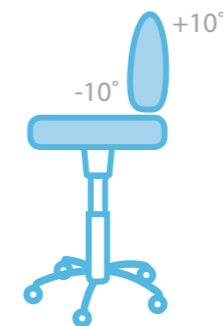

**Backrest**



38cm

**Seat Pad**

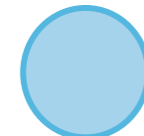

40cm

## General Medical Chairs



Suitable for a wide range of medical procedures, these chairs provide comfort and support for clinicians sitting for long periods. The deep padded round seat features a pressure reducing foam membrane and in combination with the fully adjustable backrest, promotes good posture and comfort. There is a choice of standard or high models, with high models also featuring a Foot Support Ring as standard.

## Features

- Deep padded seat with pressure reducing foam
- Suitable for long periods of sitting
- Weight capacity and safe working load of 150Kg
- Wide choice of models available
- Anti-bacterial and waterproof vinyl upholstery
- Restraint castors fitted as standard

## Optional Accessories

- 6178** Anti-static castors
- 6455** Load locking castors
- 6172** Manual locking castors
- 6173** Glides for added stability on high models
- 6175** Height adjustable armrests
- 6174** Foot height control operation
- 6176** Foot support ring for standard model

## Models

- MC6178** Round medical chair - standard model
- MC6179** Round medical chair - high model  
Foot support ring fitted as standard



Model MC6179 General medical chair, high model with optional foot height control



Model MC6178 General medical chair, standard model. Colour Cobalt Blue



Model MC6179 General medical chair, high model with optional height adjustable armrests. Colour Cobalt Blue



**MC6158**  
45cm to 59cm

**MC6159**  
54cm to 74cm

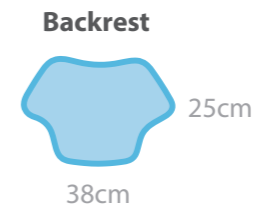

## Surgeons & Sonographers Chair



The surgeons and sonographers chairs feature an ergonomically designed seat pad and smaller backrest that will not impede the movement of the arm during scans and procedures. The curvature design and seat pad adjustment encourages pelvic tilt, prevents slouching and promotes positive posture. The chair is standard with a small, compact base to reduce trip hazards and features a wipe clean upholstered underside.

### Models

- MC6158** Surgeons chair - standard model
- MC6159** Surgeons chair - high model  
Foot support ring fitted as standard



Fully upholstered backrest and seat pad for ease of cleaning



Model MC6158 Surgeons and Sonographers chair, standard height model



Model MC6159 Surgeons and Sonographers chair, high model with foot support ring



Model MC6159 Surgeons and Sonographers chair with optional foot height control and armrests

### Features

- Wide choice of models available
- Ergonomically designed seat
- Compact backrest for improved scanning procedures
- Seat and backrest upholstered on both sides
- Weight capacity and safe working load of 150Kg
- Anti-bacterial and waterproof vinyl upholstery
- Restraint castors fitted as standard

### Optional Accessories

- 6178** Anti-static castors
- 6455** Load locking castors
- 6172** Manual locking castors
- 6173** Glides for added stability on high models
- 6175** Height adjustable armrests
- 6174** Foot height control operation
- 6176** Foot support ring for standard model



**MC6112**  
45cm to 59cm



**MC6111**  
45cm to 59cm



**MC6113**  
45cm to 59cm



**MC6115**  
54cm to 74cm

**MC6114**  
54cm to 74cm

**MC6116**  
54cm to 74cm



## Laboratory Chairs & Stools



Designed for use within laboratories or clean room environments. Backrests and seat pads are all manufactured using hard wearing chemical resistant polyurethane. All chairs and stools are height adjustable and can be fitted with optional foot height control and a wide choice of castors.

### Models

<b>MC6111</b>	Lab chair - standard model
<b>MC6112</b>	Lab stool - standard model
<b>MC6113</b>	Lab saddle stool - standard model
<b>MC6114</b>	Lab chair with foot support ring
<b>MC6115</b>	Lab stool with foot support ring
<b>MC6116</b>	Lab saddle stool with foot support ring

### Features

- Designed for laboratories and cold rooms
- Hard wearing chemical resistant polyurethane (PU)
- Unique design improves ergonomic posture
- Wide choice of models available
- Restraint castors fitted on all models as standard

### Optional Accessories

- 6178** Anti-static castors
- 6455** Load locking castors
- 6172** Manual locking castors
- 6173** Glides for added stability on high models
- 6175** Height adjustable armrests
- 6174** Foot height control operation
- 6176** Foot support ring for standard model



Model MC6111 Laboratory chair, standard model



Model MC6114 Laboratory chair, high model with foot support ring



Model MC6113 Laboratory saddle stool



Model MC6115 Laboratory stool, high model with foot support ring

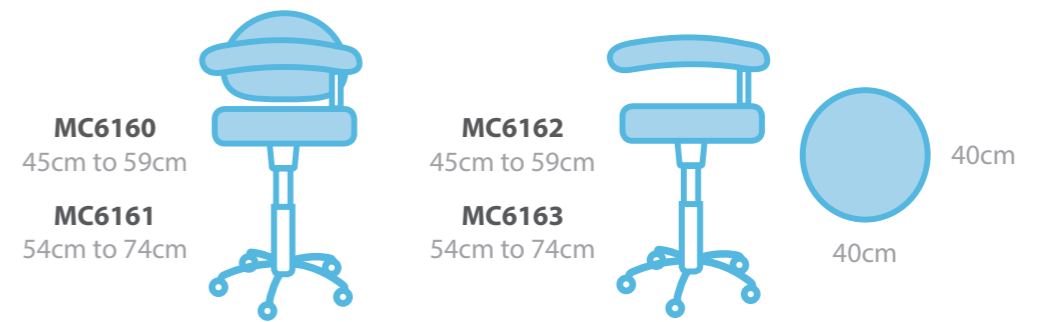

## Multi Procedures Chair



Ideally suited for Operating Suites, Ultrasound, Dentistry and Ophthalmic Departments. The 360° swing around arm provides the clinician with an armrest or torso support, using a single movement and offering additional stability during procedures. The ratchet system allows the armrest to be adjusted towards or away from the clinician, providing the user with a variety of options for different procedures. The height of the arm can also be adjusted, ideal if it is being used to support the torso. The backrest models provide additional support and comfort. All models are available with a foot height control as an option.

### Models

- MC6160** Chair with 360° swing around arm with backrest - standard model
- MC6161** Chair with 360° swing around arm with backrest - high model  
Foot support ring fitted as standard
- MC6162** Chair with 360° swing around arm  
Standard model
- MC6163** Chair with 360° swing around arm  
High model  
Foot support ring fitted as standard

### Features

- Wide Choice of Models Available
- Intelligent & Ergonomic Design
- 360° Swing around arm fitted on all models and can be used as a backrest or armrest
- Safe Working Load of 150kg
- Upholstery vinyl is Anti-Bacterial, Fireproof to Crib 5 and Waterproof
- Glides (Static Feet) fitted as standard
- Available in a wide range of colours

### Optional Accessories

- 6178** Anti-static castors
- 6455** Load locking castors
- 6172** Manual locking castors
- 6173** Glides for added stability on high models
- 6174** Foot height control operation
- 6176** Foot support ring for standard model



Fully adjustable 360° swing around arm fitted as standard on all models



Model MC6163 shown as standard with foot support ring



Model MC6161 shown as standard with backrest



Foot Support Ring fitted as standard on Models MC6161 & MC6163



**MC6172**  
50cm to 64cm

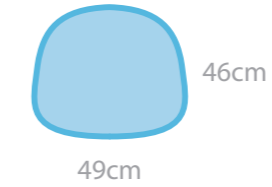

**MC6154**  
50cm to 64cm

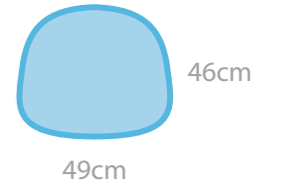

**MC6155**  
50cm to 64cm

## Ophthalmology Chair



The chair has a low seat height for patient mount and dismount and the hydraulic height adjustment enables the clinician to alter the position of the seated patient to the desired height before carrying out procedures and examinations. The arms provide maximum support for the patient as they mount and dismount the chair. The headrest is able to adjust in height and angle for optimum comfort and positioning.

### Models

**MC6172** Ophthalmology Chair - Hydraulic



Fully adjustable headrest



Model MC6172 in Sky Blue

## Phlebotomy Chair



The hydraulic height adjustable phlebotomy chair enables the operator to easily and accurately position the patient for blood sampling procedures. The chair is a compact and space saving alternative to electrically operated chairs and couches. Supplied with a sturdy base on glides (static feet) to ensure the patient is secure. Integral arm supports are fitted as standard to assist the patient in mounting and dismounting the chair. The chair has a height range of 50cm to 64cm. These models are available with a choice of single or dual phlebotomy armrests.

### Models

**MC6154** Hydraulic phlebotomy chair with single adjustable armrest.  
**MC6155** Hydraulic phlebotomy chair with dual adjustable armrests.



Fully adjustable moulded arm supports



Model MC6155 in Dark Blue



## Orwell



The Orwell collection features a shaped backrest for comfort, support and ease of function, designed for long term usage. The ergonomically designed backrest and inflatable adjustable lumbar provides corrective orthopaedic support for the lower sacral, mid-lumbar & upper thoracic vertebrae. The waterfall seat pad reduces pressure from underneath the thighs, providing comfort and assists in promoting positive posture. A seat slide is fitted as standard to further improve posture and sitting position.

### Models

- 6183 High backrest task chair
- 6184 Full backrest task chair



Headrest option available



Other armrest options available



Model 6184 Orwell full backrest task chair shown with optional height adjustable armrests, aluminium base and castors. Colour scuba

## Havering



Our Havering range of task chairs are designed for sustained use and incorporate a square shaped backrest with cold-cure contoured foam for prolonged comfort. The waterfall seat pad reduces pressure from under the thighs and assists in improving positive posture. The 3 lever heavy-duty mechanism provides independent adjustment for height and backrest angle and features a tensioning device for improved control of the seat pad tilt.

### Models

- 6261 High backrest task chair
- 6262 Full backrest task chair



3 lever heavy-duty mechanism



Model 6261 Havering high backrest task chair with optional armrests and seat slide. Colour havana



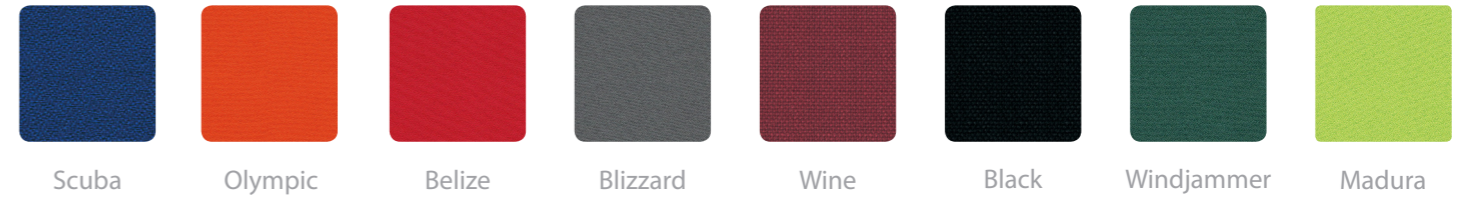

## Ixworth



The ergonomically designed Ixworth collection meets the high demands of the modern office environment. The backrest features a breathable mesh fabric, encouraging air circulation and ventilation. This range is available with choice of either the 3 lever mechanism with independent adjustment, tension control and 8 position auto-backrest or the synchro-mechanism models which have a fixed height backrest and choice of round or square seat pad with waterfall design. All models feature an integral adjustable lumbar support to promote positive posture.

### Models

- 6191** 3 lever mechanism and mesh backrest
- 6192** Synchro-mechanism and mesh backrest
- 6193** Synchro-mechanism and mesh backrest and square seat pad



3 lever mechanism with independent adjustment and seat pad tension control for improved posture



Model 6191 Ixworth 3 lever mechanism task chair with auto-adjustable 8 position mesh backrest. Colour scuba

## Sorrel



The Sorrel range provides a versatile choice of office seating. All task chairs include contoured seat pad and backrest as standard. Height adjustable models feature seat pad tilt, auto-backrest height adjustment and black nylon base and castors. The Sorrel range has a variety of backrest and seat pad sizes available to suit individual user requirements.

### Models

- 6271** Medium backrest task chair with standard seat pad
- 6272** High backrest task chair with standard seat pad
- 6273** Full backrest task chair with large seat pad
- 6274** Draughtsman chair with medium backrest, standard seat pad and foot support ring. Glides fitted as standard



Model 6271 Sorrel task chair with medium backrest



Model 6273 Sorrel task chair with full backrest and optional armrests. Colour forest

## Optional Accessories

 <p><b>6178</b> A set of anti-static castors.</p>	 <p><b>6455</b> Load locking castors automatically lock when weight is applied to the chair or stool.</p>
 <p><b>6172</b> Manual locking castors provide the user with the option to manually lock each castor.</p>	 <p><b>6173</b> Glides (also know as static feet) enable the chair or stool to be kept in a fixed position at all times.</p>
 <p><b>6175</b> Height adjustable armrests with black swivel pads provide comfort for the user.</p>	 <p><b>6348</b> Fold-back armrests provide flexibility and enables the user to fold the arms down to 90° for convenience.</p>
 <p><b>6174</b> Foot height control (FHC) enables the height to be altered via foot operations as opposed to hand operation</p>	 <p><b>6176</b> Foot support ring (Fitted as standard on high models). Not to be used with Model 6174 Foot height control.</p>

If you have any queries on any of the optional accessories listed above please contact us for further details. Please note some of the accessories are supplied as standard with specific chairs so please ensure you check before purchasing your chosen product as all other options come at an additional cost.

## 2018 Colour Range

A very hard wearing vinyl that will retain its performance for many years. Abrasion Resistance to 150,000 cycles.

White	Light Grey	Dark Grey	Black	Pepper
Sky Blue	Canard	Dark Blue	Olive	Lotus Green
Cream	Brown	Poterie	Red	Burgundy

### Other colours are available on request

**Please Note:** The illustrated vinyl colours may vary slightly from actual vinyl supplied. This occurs due to the four colour printing process. However every attempt has been made to make them as accurate as possible.